

## Features & Benefits

Stainless Steel Clamp Design with Convenient Assembly and Separation of Lamp Body

Adjustable Lumen Output with Three Lumen Gears - LV1, LV2, LV3

Color Temperature CCT Adjustable/Selectable  
3500K/4000K/5000K

PIR Sensor and Emergency Battery Optional

Surface Mount or Pendant Mount For All Applications

Hole Heat Dissipation Design to Achieve Longer Life

Standard 1-10V Dimming

5 Year Limited Warranty



## CCT and Wattage Selectable

This fixture has the function of adjusting the lumens output and color temperature on-site.

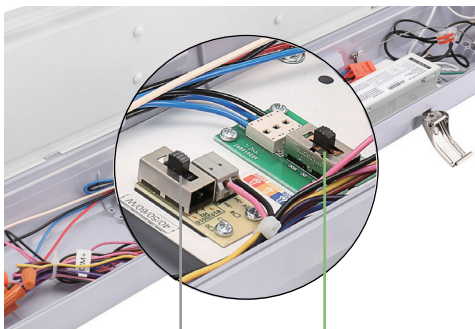

### WATTAGE SELECT



Each model supports 3 positions  
wattage regulation :  
LV1, LV2, LV3

### CCT SELECT



Offer three CCT adjustable  
(3500K, 4000K, 5000K).

## Technical Parameters

Power	Light Output	Input	Operating Temperature	Efficacy
25W - 90W	3,500 lm - 8,800 lm	120-277V	-22°F - 122°F	Up to 152 lm/W

Color Temperature	CRI	Certifications	Motion Sensor	Dimming
3500K, 4000K, 5000K	80	UL	Bi-Level PIR Sensor	1-10V Dimming

Emergency Battery	Mounting	Finish		
8W 900 lm	Pendant, Surface	W, D, B		

## Performance Data

VTL04-4FT-50W							
Setting	System Watts	3500K		4000K		5000K	
		Lumens (80CRI)	LPW (80CRI)	Lumens (80CRI)	LPW (80CRI)	Lumens (80CRI)	LPW (80CRI)
LV1	50W	6,700 lm	134 lm/W	7,100 lm	142 lm/W	6,900 lm	138 lm/W
LV2	35W	4,870 lm	137 lm/W	5,100 lm	146 lm/W	4,900 lm	140 lm/W
LV3	25W	3,500 lm	140 lm/W	3,800 lm	152 lm/W	3,560 lm	142 lm/W

VTL04-8FT-90W							
Setting	System Watts	3500K		4000K		5000K	
		Lumens (80CRI)	LPW (80CRI)	Lumens (80CRI)	LPW (80CRI)	Lumens (80CRI)	LPW (80CRI)
LV1	90W	12,200 lm	136 lm/W	12,800 lm	142 lm/W	12,500 lm	139 lm/W
LV2	75W	10,300 lm	137 lm/W	10,800 lm	144 lm/W	10,500 lm	140 lm/W
LV3	60W	8,300 lm	138 lm/W	8,800 lm	147 lm/W	8,500 lm	142 lm/W

# Ordering Information *Example: VLT04-2FT-50W-XXK*



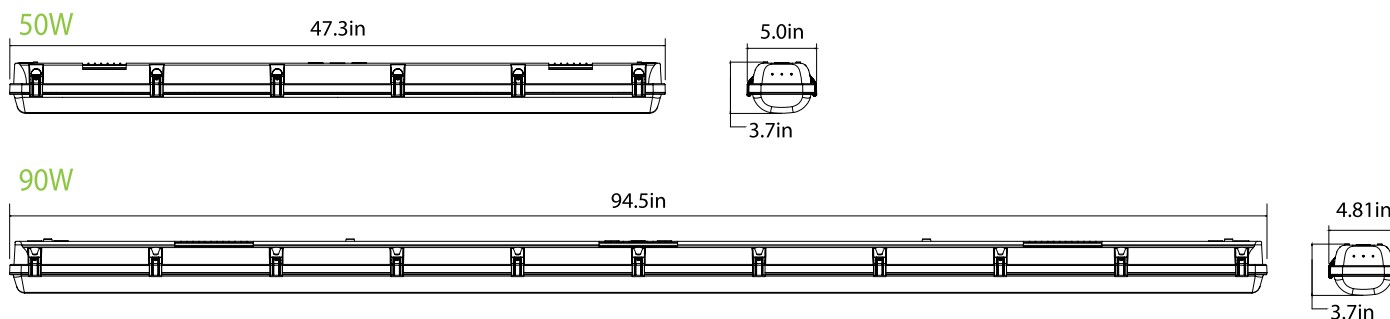

(Optional)

Model	Length	Wattage	Voltage	CCT	Controls
<b>VTL04</b> Vapor Tight VTL04 Series	4FT	50W 90W	<b>Blank</b> 120-277V	<b>XXK</b> 3500K/ 4000K/5000K  <b>40K</b> 4000K <b>50K</b> 5000K	<b>Blank</b> No Sensor <b>M</b> Motion Sensor <b>EM</b> Emergency Battery <b>MEM</b> Motion Sen- sor + Emergency

## Product Dimensions

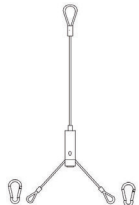

## Accessories

 <p>Mounting Bracket (Default)</p>	 <p>Emergency Battery 8W 900lm 90min (Sold separately)</p>	 <p>Microwave Sensor NO.: HD027VCR Description: 12VDC input (Sold separately)</p>
 <p>Chain Description: 30cm long (Default)</p>	 <p>Hardware bag (Default)</p>	 <p>Aircraft Cable Description: 3m long (Sold separately)</p>